



INSTRUCTIONS D'ASSEMBLAGE
ASSEMBLY INSTRUCTIONS

MONARCH
SPECIALTIES INC.

I 5910F

LIT -
DOUBLE / SIMILI-CUIR BRUN FONCE

BED -
FULL SIZE / DARK BROWN LEATHER-LOOK



**POUR DE L'ASSISTANCE OU POUR COMMANDER
DES PIÈCES CONTACTEZ NOTRE DÉPARTEMENT
DE SERVICE À LA CLIENTÈLE.**

**FOR ASSISTANCE OR TO ORDER PARTS
CONTACT OUR CUSTOMER SERVICE DEPARTMENT**

WWW.MONARCHSERVICE.COM

LISTE DES PIÈCES
PARTS LIST

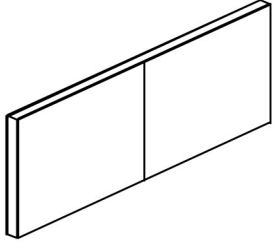
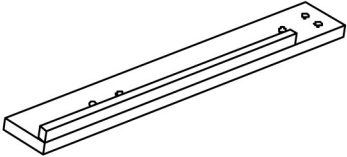
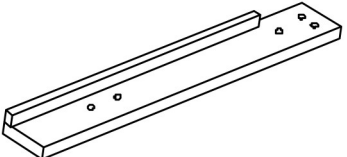
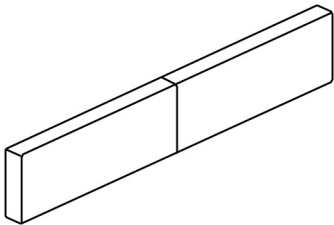
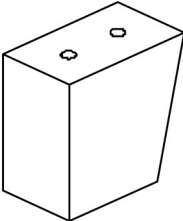
PIÈCE / PART #	IMAGE	DESCRIPTION	QTY / QTÉ
1		HEADBOARD TÊTE DE LIT	1
2		FRONT FACING HEADBOARD LEFT LEG TÊTE DE LIT AVANT GAUCHE	1
3		FRONT FACING HEADBOARD RIGHT LEG TÊTE DE LIT AVANT DROITE	1
4		FOOTBOARD PIED DE LIT	1
5		FRONT FACING FOOTBOARD LEFT LEG PIED DE LIT AVANT GAUCHE	1

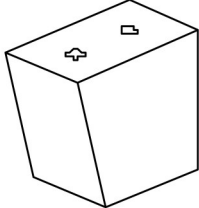
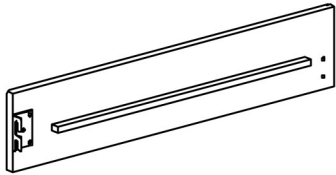
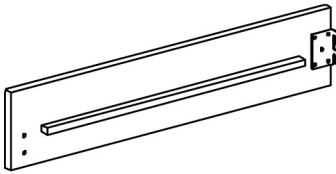
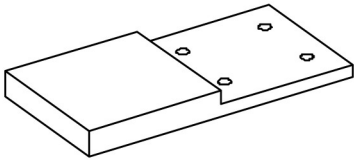
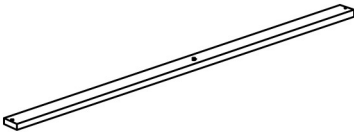

LISTE DES PIÈCES
PARTS LIST

PIÈCE / PART #	IMAGE	DESCRIPTION	QTY / QTÉ
6		<p>FRONT FACING FOOTBOARD RIGHT LEG PIED DE LIT AVANT DROIT</p>	1
7		<p>FRONT FACING LEFT SIDE RAIL RAIL DE CÔTÉ GAUCHE</p>	2
8		<p>FRONT FACING RIGHT SIDE RAIL RAIL DE CÔTÉ DROIT</p>	2
9		<p>SIDE RAIL SUPPORT LEG RAIL DE CÔTÉ PATTE DE SOUTIENT</p>	2
10		<p>SLAT LAMELLE</p>	4

LISTE DES PIÈCES
PARTS LIST

PIÈCE / PART #	IMAGE	DESCRIPTION	QTY / QTÉ
11		SUPPORT LEG PATTE DE SOUTIEN	4

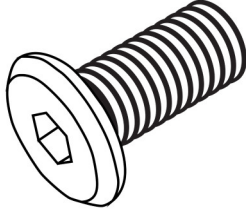
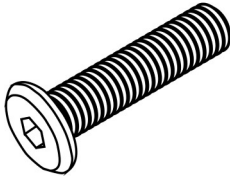
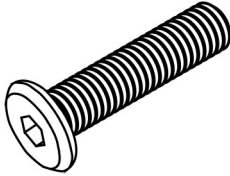
LISTE DES PIÈCES DE MONTAGE
HARDWARE LIST

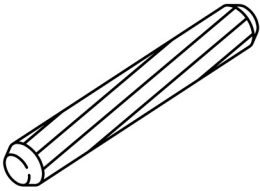
PIÈCE / PART #	IMAGE	DESCRIPTION	QTY / QTÉ
A		<p align="center">ASSEMBLING BOLT - Ø 3/8" X 3/4"</p> <p align="center">BOULON D'ASSEMBLAGE - Ø 3/8" X 3/4"</p>	8
B		<p align="center">ASSEMBLING BOLT - Ø 1/4" X 7/8"</p> <p align="center">BOULON D'ASSEMBLAGE - Ø 1/4" X 7/8"</p>	8
C		<p align="center">ASSEMBLING BOLT - Ø 1/4" X 1 3/8"</p> <p align="center">BOULON D'ASSEMBLAGE - Ø 1/4" X 1 3/8"</p>	10
D		<p align="center">ASSEMBLING BOLT - Ø 1/4" X 2 3/4"</p> <p align="center">BOULON D'ASSEMBLAGE - Ø 1/4" X 2 3/4"</p>	2
E		<p align="center">WOOD DOWEL</p> <p align="center">GOUJON DE BOIS</p>	2

LISTE DES PIÈCES DE MONTAGE
HARDWARE LIST

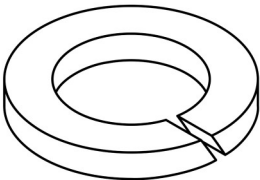
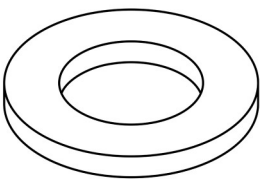
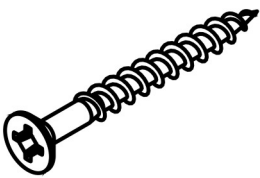
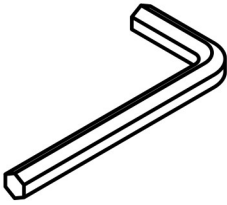
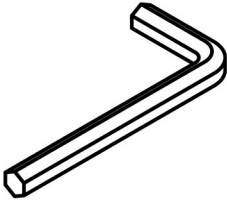
PIÈCE / PART #	IMAGE	DESCRIPTION	QTY / QTÉ
F		LOCK WASHER ENTRETOISE DE MÉTAL	14
G		METAL WASHER RONDELLE DE MÉTAL	14
H		ASSEMBLING SCREW - Ø 1/8" X 1 1/4" VIS D'ASSEMBLAGE - Ø 1/8" X 1 1/4"	8
I		HEX KEY - M5 , 4MM CLÉ HEXAGONALE - M5 , 4MM	1
J		HEX KEY - M4 , 3MM CLÉ HEXAGONALE - M4 , 3MM	1

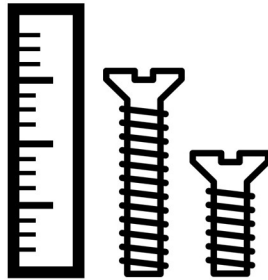

OUTIL DE VÉRIFICATION DE DIMENSIONS DES PIÈCES
HARDWARE DIMENSIONS VERIFICATION TOOL

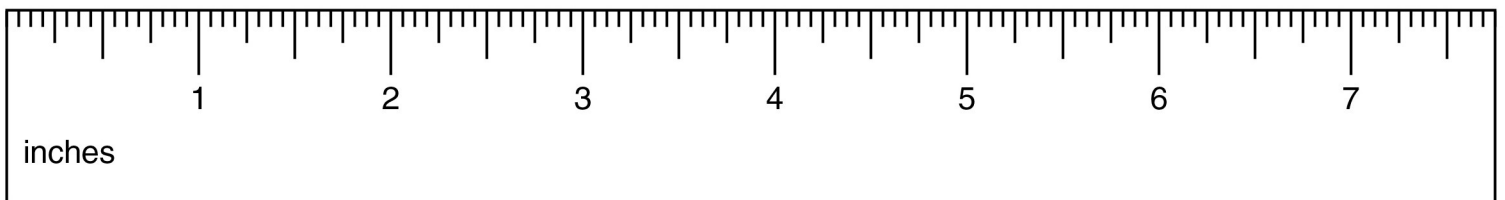

ÉTAPE / STEP 1

La quincaillerie et les composants sont situés dans l'unité de la tête de lit.

Hardware and components are located in the headboard unit.

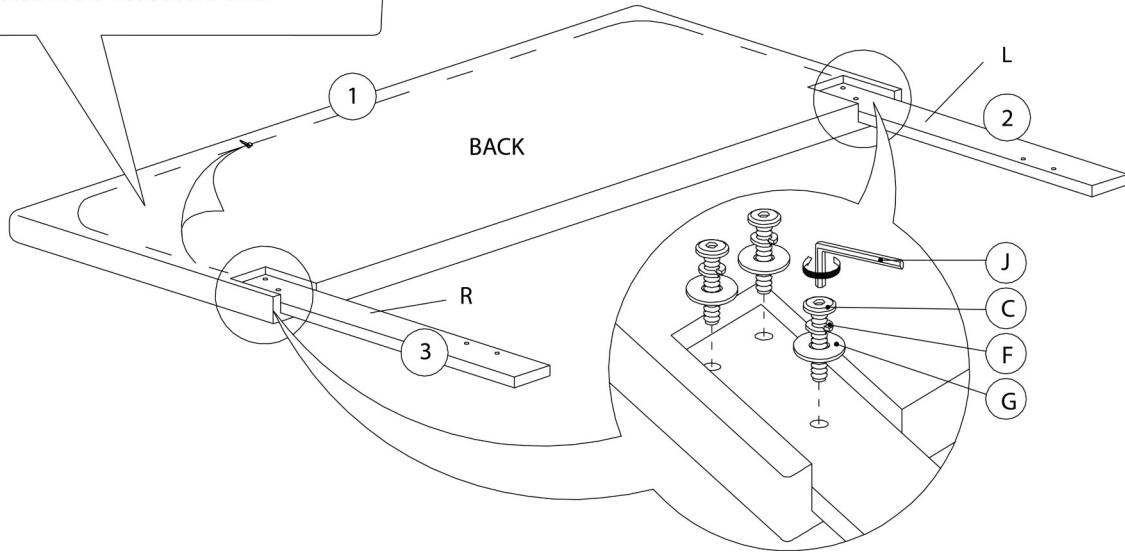

ÉTAPE / STEP 2

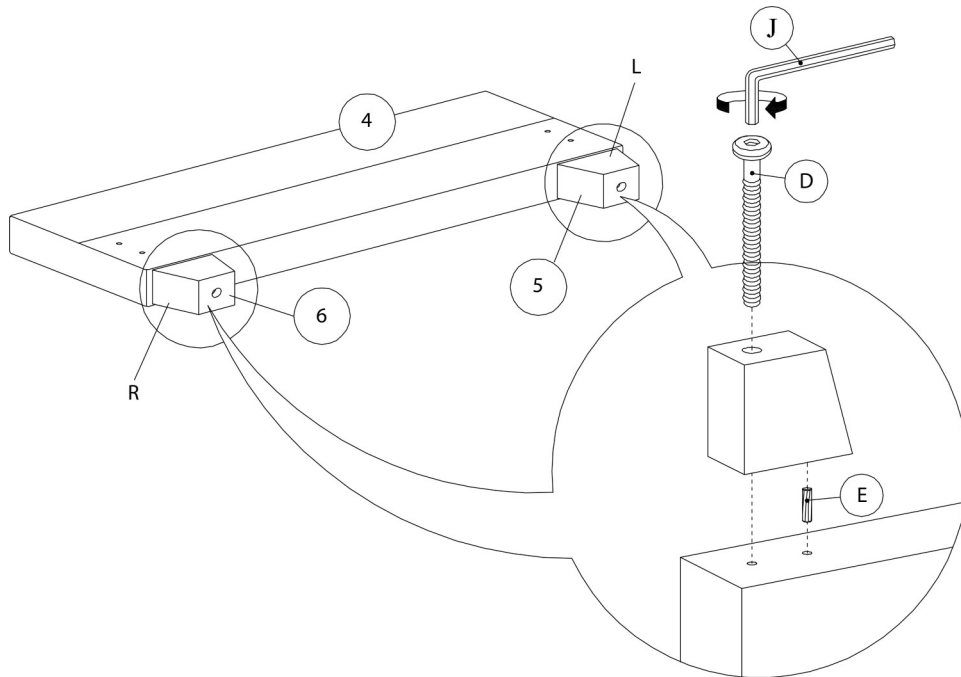

ÉTAPE / STEP 3

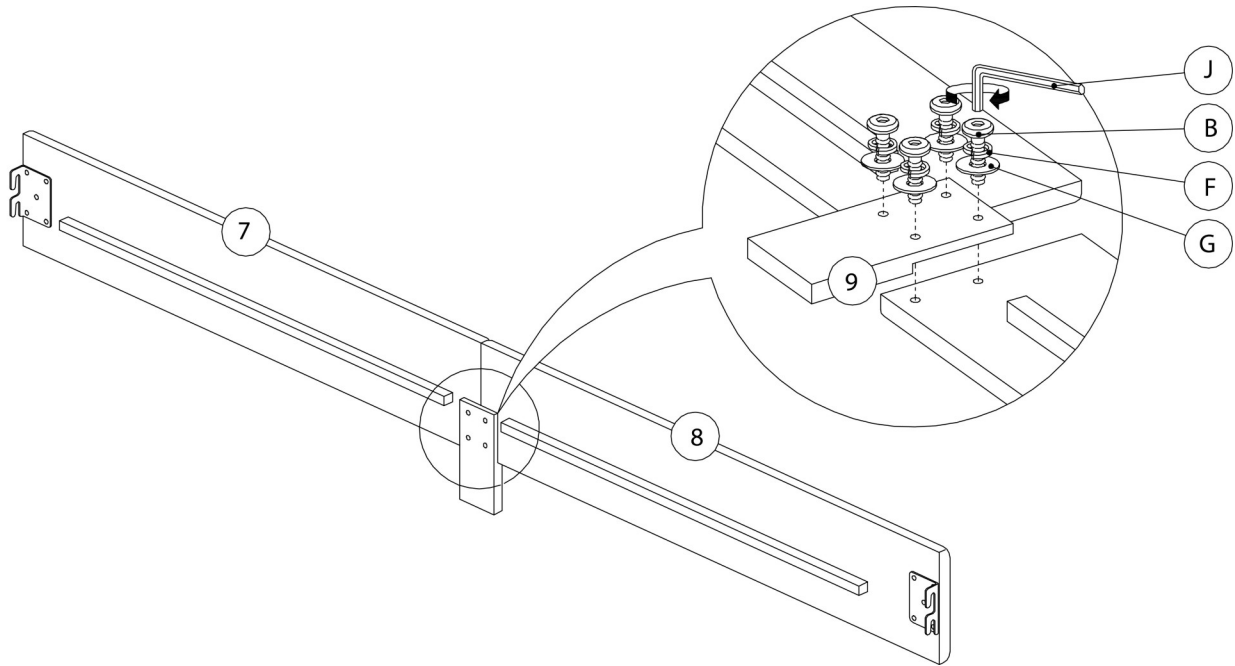

ÉTAPE / STEP 4

